

# Data Sheet



Article number: 12509700040100  
Description: KLEE-coil 509 700 040.100  
M4 Hardened, zinc-pl.

## Measures

---

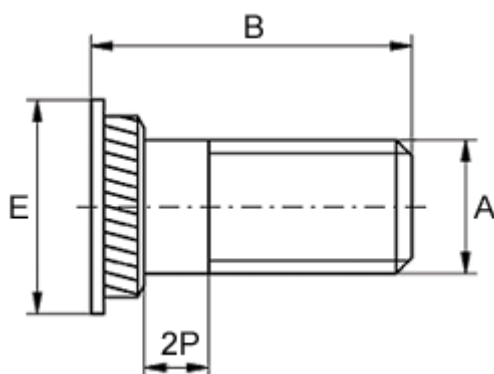

For plate thickness, min	= 1.5
Head diameter E	= 7
Hole diameter +0.1	= 6.4
Length B	= 9
Male thread A	= M4x0,7
Min distance to edge	= 3.3